

DELTA-RK

Combination cowl,
pressure controlled

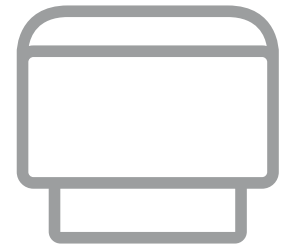

COWLS

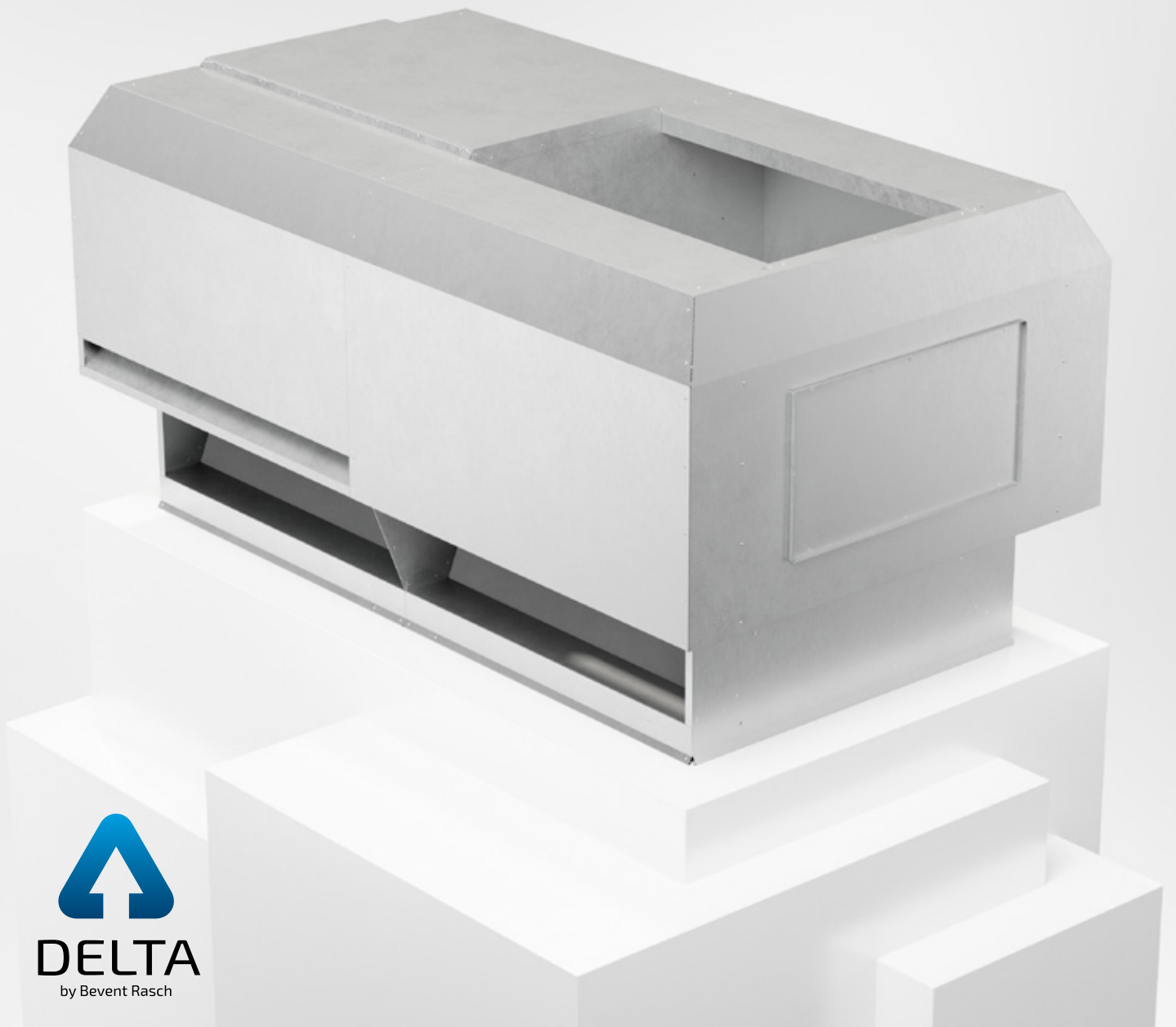

03/07/2024



Combination Cowl DELTA-RK, pressure controlled



Quick facts

- Sizes from 600 mm to 1400 mm
- Object-adapted regulation
- Keeping the pressure in the exhaust air constant gives an even air speed
- For installations with greater flow variations
- Always right outlet area
- Suitable for roof inlet BRTF

Användningsområde

DELTA-RK is a cowl with object-adapted regulation. The cowls are based on our fine DELTA concept and can be delivered in customer or project-specific designs, e.g.:

- Regulating actuators are controlled from the master system
- Constant pressure holding function

As standard the cowl is designed with regulation that maintains a constant pressure and speed ratio across the flow area and is suitable for installations with large flow variations. Just as easy-to-install as a standard cowl and is connected with 10 A, 230 V.

Roof inlet with cable channel is supplied as standard to DELTA-RK.

The electronics and moving parts in the cowl are protected and easily accessed through the service hatch on the side of the cowl. Easy programming after commissioning ensures quick installation.

Delta-RK adapts the exhaust air opening to the current flow of the ventilation system and ensures the pressure and speed ratio in the duct system. This provides adaptable regulation in plants with large flow variations. Plants with high and low-speed operations are always given optimal speed on the exhaust air. If necessary, the outlet speed can be increased to prevent external short circuits. Increased outlet speed prevents odours and used air from disturbing the surroundings and nearby properties.

Specification

Exempel:

Combination Cowl DELTA-RK - 800 - 1 - 0 - 1

Size, see size table

Material:

Magnelis = 5

Stainless EN 1.4404 = 3

Surface treatment:

Unfinished = 0

Painted finish = 1*

Regulation:

Pressure holding = 1

(Regulator Calectro)

Pressure holding + Modbus = 2

(Regulator A-CTRL)

Project specific (specified separately) = X

* Colour code should be stated in plain text, see www.bevent-rasch.com

Accessories:

Roof inlet BRTF with cable channel

Material, finish

- Metal parts in Magnelis according to corrosivity class C4 alternatively in Stainless EN 1.4404 according to corrosivity class C5
- The cowl can be painted in the desired color

Special

The cowl can be equipped as required. The control equipment in the cowl can be specified as desired for optimal operation.



Function description

The cowl's regulating outlet keeps the duct pressure constant and ensures the required outlet speed.

The pressure regulator's control signal regulates the outlet using electrical actuators.

The cowl is equipped with safety actuator, Belimo NF/SF24A-SR, in the standard version. If the supply voltage is broken, the cowl closes with spring force.

Safety

The cowl contains moving parts that, in the event of improper handling, may entail a risk of crushing. When powered up, the cowl works directly against the set parameter values.

Work on the cowl is carried out in a de-energised state.

Design instructions

The size of the cowl is appropriately dimensioned for the highest air flow of the ventilation system. Control equipment is selected according to the options in the order code or in consultation with us for optimal function. In order to obtain adaptable regulation, DELTA-RK does not have an internal drainage plate, thus drainage of the duct system is always recommended.

When adjusting the cowl, the required pressure is set and the regulation speed is adjusted according to the flow variations of the system.

DELTA-RK in MagiCAD

In MagiCAD, DELTA-RK is set up in the database with product data for open to closed damper angle and a relevant flow area. We recommend using the "Lock dp" function or similar to lock the projected pressure across the cowl. If the pressure drop is not manually locked, the lowest pressure drop for the flow area of the cowl will automatically be selected, which does not reflect the intended constant pressure holding function of the cowl.

Commissioning instructions

Delta-RK is delivered ready for commissioning. Power the cowl's transformer with a voltage of 230 V from a separate 10 A fuse. Circuit breakers must be used and located on the cowl. Control equipment and regulation in the product are operated with protective low voltage, 24 V AC, via the transformer located behind the cowl's service hatch.

In its basic design, DELTA-RK for pressure holding is delivered set to 50 Pa.

Connection must be carried out by a qualified installer.

Use approved material and personal protective equipment.

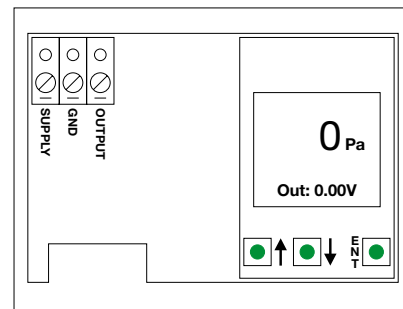

Programming the regulator:

The regulator has an illuminated display for reading as well as 3 push buttons for menu selection and setting:

↑ : Step up in the settings menu.

↓ : Step down in the settings menu.

ENT: Confirms menu selection and setting value.

Before programming:

When commissioning, it is recommended that zero pressure calibration be performed on the regulator as follows:

- 1: Loosen all external pressure hoses on the regulator.
- 2: Allow the regulator to reach working temperature.
- 3: Select submenu "0-Calibr".

The display shows when calibration is complete.

Setting of the regulator:

The cowl comes with the setting 50 Pa.

Press ENT (enter) to access the settings menu.

Menyval

Function: Pressure

Setpoint: Setting of the required operating pressure.
Rec. 40-80 Pa.

0-Calibr: Perform zero pressure calibration

Reg.speed: 1 (slow) - 10 (fast)

The cowl is delivered set to position 5.

The setting is adapted to the flow variations of the plant.

Out range: Lo 20%

Hi 100%

Setting the control signal 2-10 V.

Exit



Combination Cowl DELTA-RK, pressure controlled

Dimensions

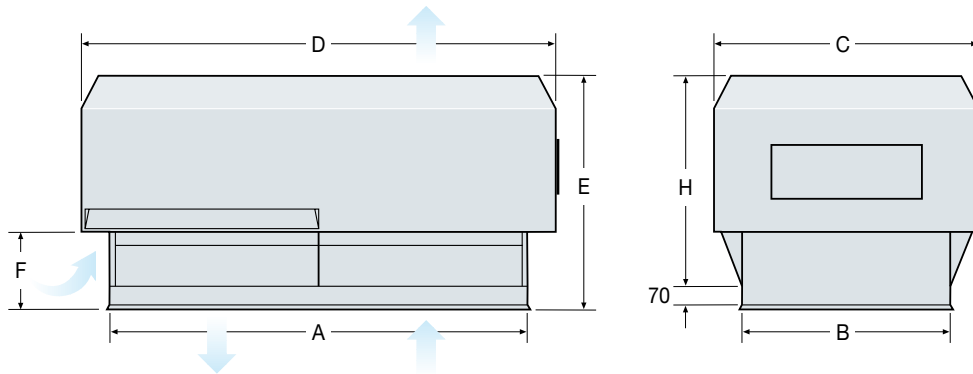

Size	A	B	C	D	E	F	H	Fits BRTF	Weight kg	Service hatch (B x H)
600	1600	800	1015	1820	910	300	810	600	96	590 x 390
800	2000	1000	1270	2270	1110	350	1010	800	143	700 x 390
1000	2400	1200	1530	2725	1315	405	1215	1000	224	840 x 410
1200	2800	1400	1780	3180	1520	455	1420	1200	300	960 x 410
1400	3200	1600	2035	3635	1720	510	1620	1400	383	1080 x 410

The product decal includes the following

- The name of the product and the design coding. See specification examples.
- Size and weight
- Order number
- Information text

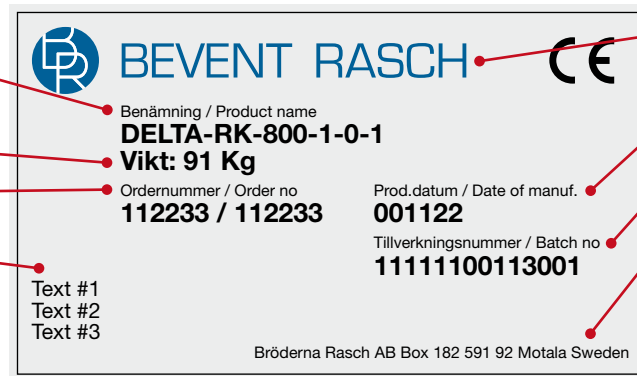

- Dealer
- Date of manufacture
- Manufacturing number
- Manufacturer

Dimensioning diagram – Outdoor air

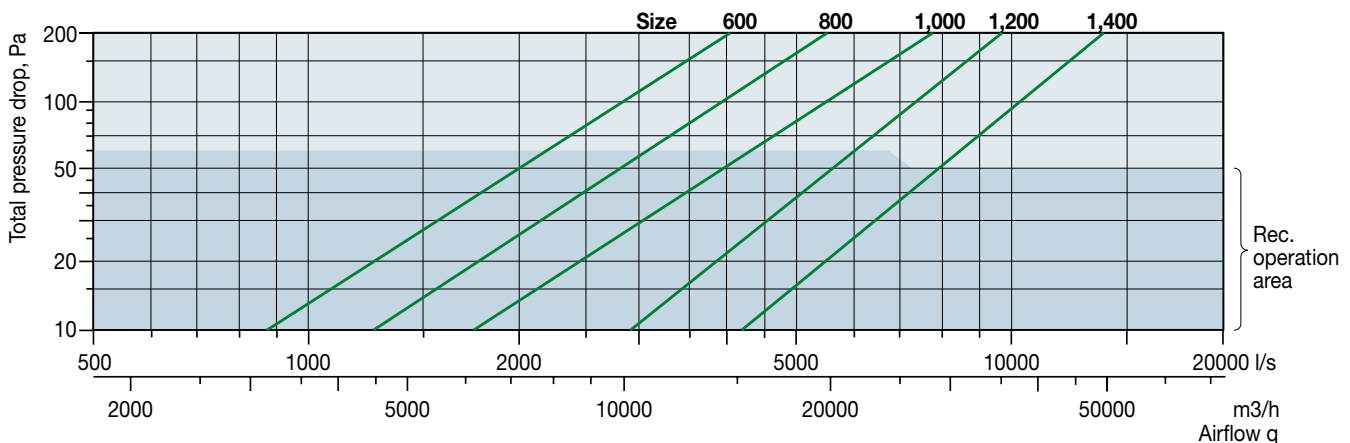



Dimensioning diagram

Size 600

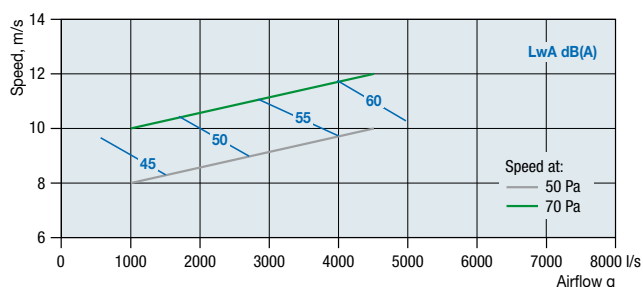

Size 1200

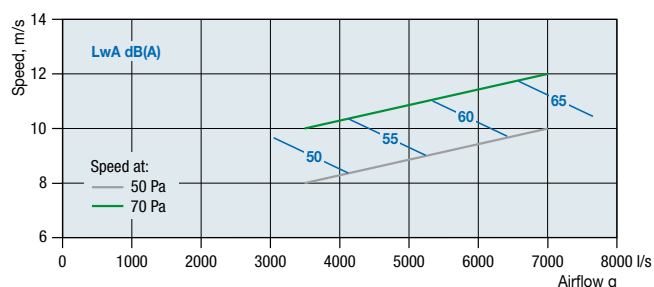

Size 800

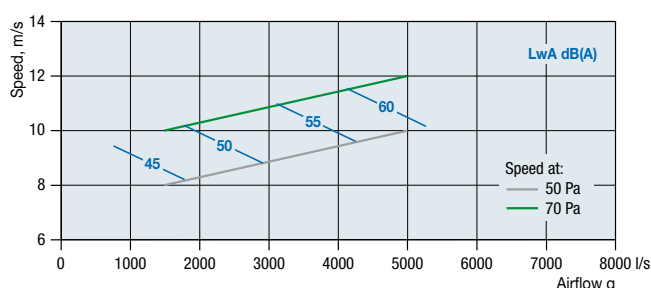

Size 1400

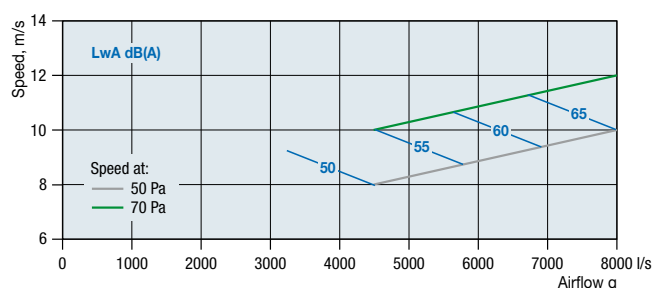

Size 1000

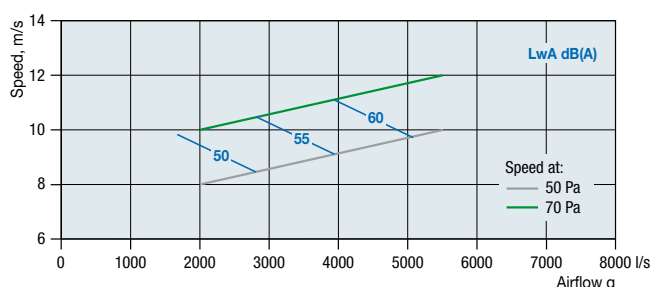

Correction of sound power level, $L_{w_{ok}}$ in octave band

$$L_{w_{ok}} \text{ (dB)} = L_{wA} + K_{ok}$$

Octave band	63	125	250	500	1000	2000	4000	8000
K_{ok}	4,4	3,1	0,5	-2,3	-5,6	-12,1	-14,4	-20,1

Reduction in sound pressure level depending on distance from roof cowl calculated on half-spherical propagation.

Distance, m	5	25	50	75	100	150
Reduction, dB(A)	-22	-36	-42	-45	-48	-52

Throw length

Distance, m	Size				
	600	800	1000	1200	1400
50 Pa	7,5	10,0	12,5	15,0	17,5
70 Pa	10,0	12,5	15,0	17,5	20,0

Throw lengths are simulated and apply in windy conditions.

The dimensions are defined in m as the distance from the cowl outlet to the point where the speed of the air plume has decreased to 2 m/s.

The specified throw length is an average value over the recommended flow range.

Temperature range

The recommended temperature range of the cowl as standard is -20°C - +50°C. For applications outside the recommended temperature range, please contact Bevent-Rasch.