

# FENIX4

Monitoring system for  
up to 16 fire dampers



FIRE SAFETY



# FENIX

07/08/2024



## FENIX



### Facts at a glance

- For monitoring up to 16 fire dampers
- Also manages 0-10 V (regulating) fire dampers
- Dynamic troubleshooting screens on the interactive touch display with action proposals for each potential fault
- Automatic detection of connected dampers and smoke detector circuits
- Selectable language Swedish/English
- Easy to expand the system with slave unit FENIX+
- Simple zoning of fire compartments
- Possibility to name dampers & smoke detectors
- Alarm history page showing the latest 30 alarms.
- Programmable alarm outputs
- Modbus TCP / BACnet IP

### System description

FENIX is the next generation system for monitoring fire dampers. The system can manage between 4-16 dampers, both ON/OFF 24 V dampers and regulating 0-10 V dampers. The modern display constantly displays an intuitive and straightforward screen that is very easy to understand, a very important function to increase the simplicity and management of such an important function as fire monitoring.

FENIX is fully backward compatible with our older generations of controllers, which means that existing cabling and dampers can be used for ROT projects.

The carefully prepared designed of FENIX results in many small values for the user. Diagonal placement of the cables

glands for cables, flashing icons to facilitate for those with colour blindness, and small descriptive help texts on each page of the display are just a few examples of how refined and adapted FENIX is for maximised user-friendliness.

### FENIX4

FENIX4 is the device with the interactive touch display. FENIX4 supports between 1-4 dampers and smoke detector circuits, which are automatically detected during commissioning.

FENIX4 is used either independently for monitoring 1-4 dampers and smoke detector circuits or together with slave units FENIX+ for up to 16 dampers and smoke detector circuits.

The connection instructions are also provided on the lid of the FENIX4 to assist installation.

### FENIX+ slave unit

FENIX+ works as an additional module for the possibility to connect an additional 1-4 dampers and smoke detector circuits to the system. The FENIX+ slave unit is automatically identified by FENIX4 and connected dampers and smoke detector circuits are automatically shown as usual on the display of FENIX4. FENIX+ is addressed easily with a physical knob, see the connection instructions for more information.

The benefits of FENIX+ are numerous, instead of an additional controller, you get a cost-effective solution to expand a system with additional connection points. Instead of the traditional cable routing between each damper and the main unit, you can save cable by mounting the slave units FENIX+ out in the installation, closer to the dampers and smoke detector circuits.

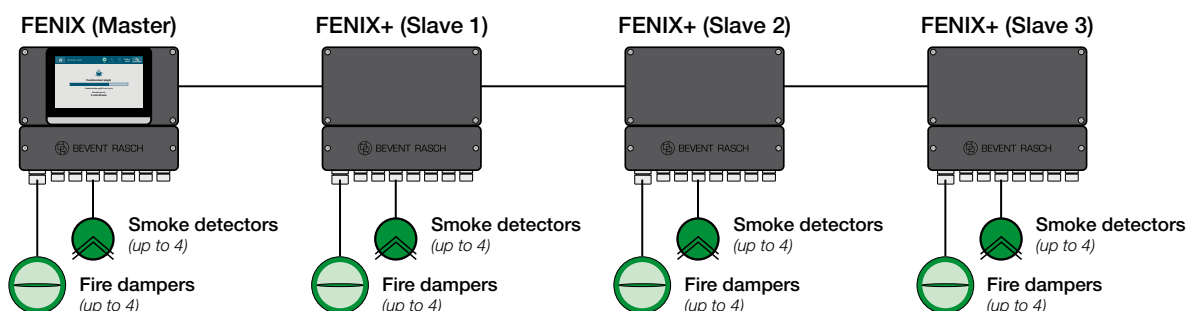



The connection instructions are also provided on the lid of the FENIX+ to assist work on site. A maximum of 3 FENIX+ units may be connected in series to a FENIX4.

### **FENIX 0-10 V module**

When using regulating fire dampers, regulation can be performed in two different ways, either via a local 0-10 V signal out at the damper or via master communication (Modbus TCP or BACnet IP). If local control is desired with 0-10 V, the FENIX 0-10 V module is used to separate the local control signal, from, e.g. a room sensor, and the 10 V signal from FENIX that takes over during a functional test to check that the dampers can open.

## **Function description**

### **Functions and settings via the display**

#### **Date and Time**

The date and time are set from the factory, but can be easily changed on-site if necessary. The unit is equipped with automatic summer and winter time adjustment.

#### **Language**

Easily choose between Swedish and English.

#### **Zone dampers and smoke detector circuits**

The dampers and smoke detector circuits can easily be divided into up to four zones. The zones then serve as their own fire compartments and the smoke detector circuits can close one or more zones. This is a function that can be used, for example, for tenant adaptations where the entire system should not shut down on each local smoke detector circuit. Default setting: all smoke detectors and fire dampers belong to zone 1.

#### **Time of functional testing**

Easily set the interval when functional testing of the fire dampers is performed and when during the day to do it. Selectable ranges:

- 1 time every 24 hours
- 1 time every 48 hours  
(recommended and default setting on delivery)
- 1 time per week
- 1 time per month
- 1 time every 6 months

#### **Perform functional testing**

If necessary, you can easily perform a functional test via the display on FENIX4. Can also be performed by shorting terminals 32 and 33.

### **Device information and communication settings**

Simply set the desired communication settings for Modbus TCP or BACnet IP via the display.

IP address is assigned automatically via Dynamic Host Configuration Protocol (DHCP). If a fixed IP address is desired, this can be configured via the settings in the touch display.

#### **Delay External stop**

If desired, functional testing of fire dampers can be delayed by 5 minutes. Relay "EXT. STOP" between terminals 44 and 45 then breaks directly for internal functional testing, the functional test of the dampers is performed first after a 5 minute delay, which then allows the electric heating coils to cool down. Default setting: no delay.

#### **Automatic reset of External incoming alarm**

Normally an External incoming alarm (34 + 35) needs to be acknowledged on the unit via the display or terminal block 32 + 33 (default setting), this function permits External incoming alarms to be acknowledged automatically when a possible external alarm stops. Default setting: no automatic reset.

#### **System reset**

The system is easily reset to the default settings when necessary.

#### **Alarm history**

Shows the 30 latest alarms divided on two pages. The list is of the type FIFO, the latest alarm is always shown on row 1 och new alarms will be shown when generated.

#### **Name damper and smoke detectors**

On these pages dampers and smoke detectors can be named and their location can be noted. The pages will only show the physical dampers and smoke detectors that are connected.

NOTE! The information written here will only be shown on these pages, not on the regular overview.

#### **Programable alarm outputs (Alarm Settings)**

On this page you can select which alarm conditions that will affect the separate alarm outputs.

The former alarm outputs "Sumalarm" and "Detector service alarm" are now called "A-alarm" and "B-alarm".

NOTE! The selections on this page will only affect the alarm outputs, dampers will still close if an alarm is triggered.



## **Automatic functions integrated in FENIX**

### **Dynamic troubleshooting diagrams**

Instead of the traditional troubleshooting documents that previously accompanied older controllers, FENIX shows exactly what fault occurred and proposed actions directly on the display, such as if a damper does not make contact with the limit switch for the closed position:

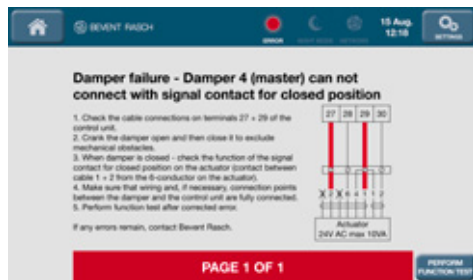

The unit then shows exactly what damper fault has been identified, the possible slave unit FENIX+ that the damper belongs to and which connection terminals and cables should be checked and troubleshot. This function facilitates any service and troubleshooting in the event of a fault during the lifespan of the property. The same pedagogical approach applies to smoke detector circuits, external alarms and other functions that trigger something in the controller.

Dynamic trouble shooting diagrams and associated action texts play an important role in the simplicity of FENIX.

### **Automatic functional testing**

All connected fire dampers are automatically functionally tested. In order to ensure that regulating dampers work at all damper angles, check the limit switches for both the open and closed positions for all connected dampers.

### **Automatic shutdown of the entire system in the event of alarms in two different zones**

As a safety measure, all connected fire dampers are closed if two smoke detectors from different zones alarm at the same time. This is because it can then be assumed that the fire has spread between the fire compartments and that the entire system should be closed.



### Symbol descriptions

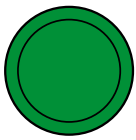

Closed damper

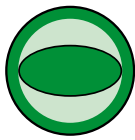

Damper in middle position

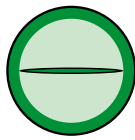

Open damper



**"DAMPER 1"**  
Indicates which damper on the unit FENIX4 / FENIX+

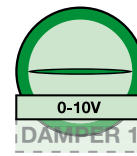

**"0-10 V"**  
Indicates whether the damper is regulating:  
0-10 V = regulating  
No box = On/Off

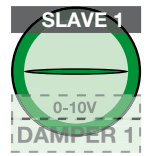

**"SLAVE 1"**  
Indicates which slave unit the damper belongs to.

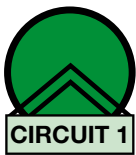

Green  
= All OK

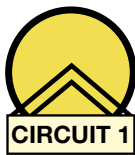

Yellow  
= Service

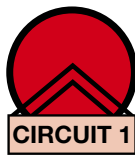

Red  
= Error / Alarm

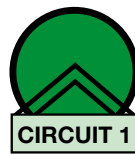

**"CIRCUIT 1"**  
Indicates which detector circuit on the unit FENIX4 / FENIX+



**"SLAVE 1"**  
Indicates which slave unit the detector circuit belongs to.

### Specification

Control unit FENIX4

Accessories:

- FENIX+ slave unit** - slave unit for an additional 4 pcs damper/detector circuits
- RCKD/-RD** - smoke detectors
- FENIX 0-10 V module** - for local regulation of 0-10 V damper
- RCHD** - overtemperature detector



## Dimensions, weight and technical data

### FENIX4

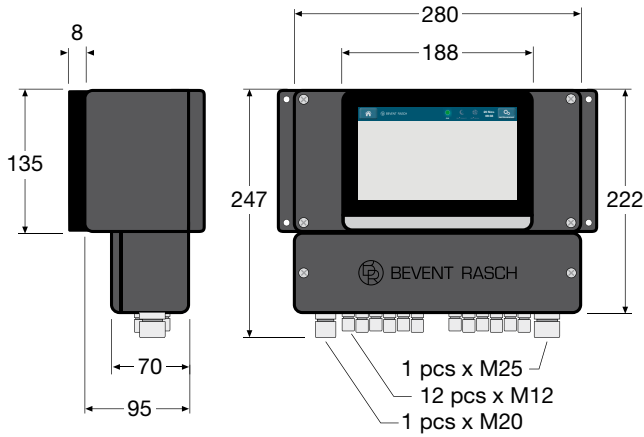

### Technical data FENIX4

Supply voltage: 230 V AC +10% -15%, 50 Hz  
 Power rating: 230 V ~ 100 VA T40  
 Enclosure class: IP 65  
 Ambient temp.: 0° – +40°C  
 Output relays: Potential free, 24 V, 3 A AC/DC @ resistive load

Max. load per damper output: 10 VA, 24V DC  
 Max. detectors per output: 2 pcs.  
 Internal fuse: 250V 1.6A

### FENIX+ slave unit

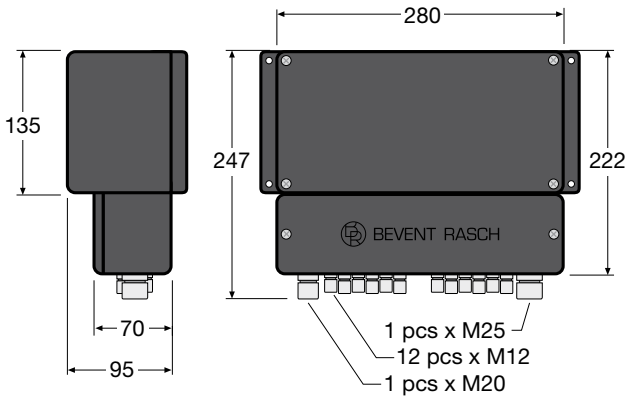

### Technical data FENIX+ slave unit

Supply voltage: 230 V AC +10% -15%, 50 Hz  
 Power rating: 230 V ~ 100 VA T40  
 Enclosure class: IP 65  
 Ambient temp.: 0° – +40°C  
 Max. load per damper output: 10 VA, 24 V DC  
 Max. detectors per output: 2 pcs.  
 Internal fuse: 250V 1.6A

### FENIX 0-10 V module

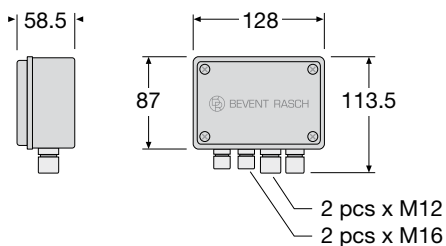

### Technical data FENIX 0-10 V module

Enclosure class: IP 56  
 Ambient temp.: 0° – +50°C



**Inputs and outputs** (For descriptions of terminals, see next page)

**FENIX4**

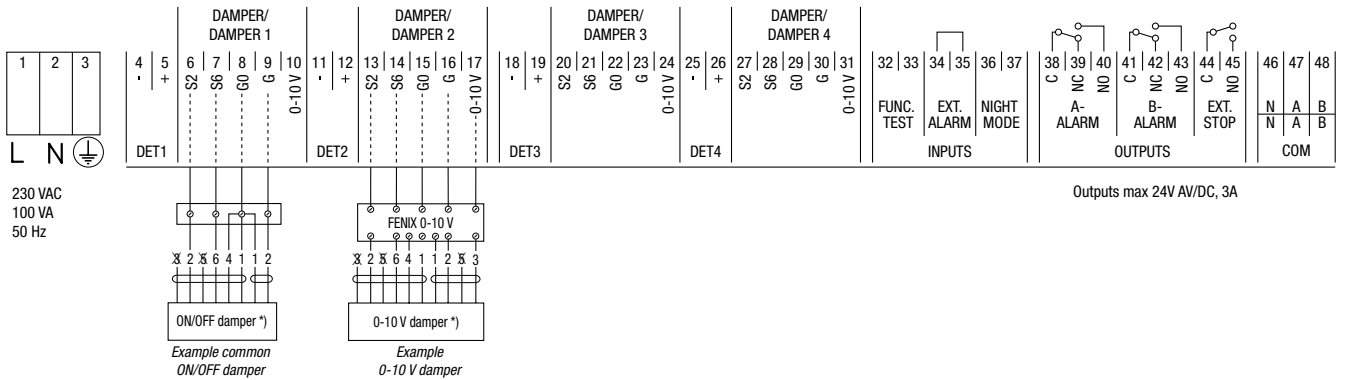

**FENIX+ slav unit**

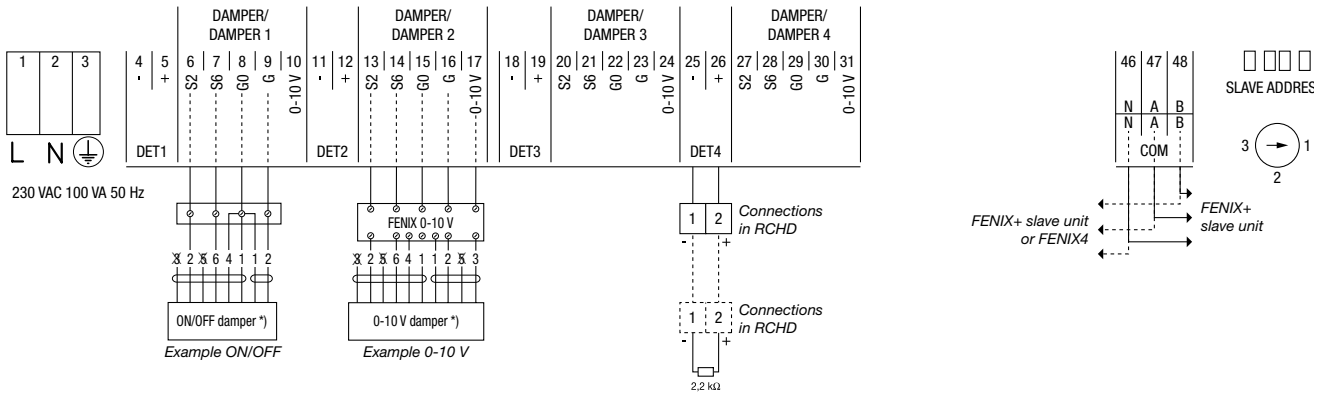

\*) 24 V DC max. 10 VA  
When separate thermal sensor is used, connect in series with motor.

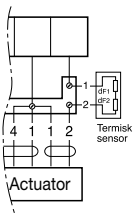

\*\*) For room detector RCRD connected in series

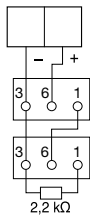

\*\*\*) For duct detector RCKD connected in series

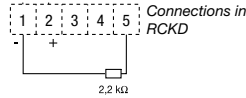
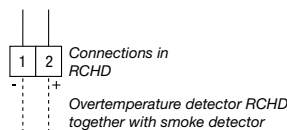
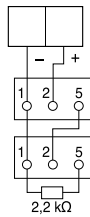

**Cable recommendations**

ON/OFF dampers, e.g. BSKC6  
= EKKR/ELQRB/EQQRB 4x1 mm<sup>2</sup>

Regulating damper 0-10 V, e.g. BSKC6R  
= EKKR/ELQRB/EQQRB 5x1 mm<sup>2</sup> (7x1 mm<sup>2</sup>)

Between FENIX4 and FENIX+ slave units:  
UTP cable AWG22, AWG24 with 2 pairs.  
A, B, N must be connected (one conductor will be over).

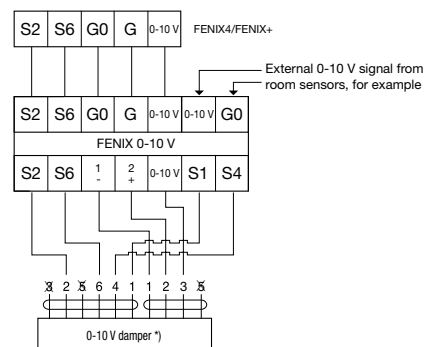

Recommended max. length between FENIX4 master and FENIX+ slave unit: 300 m.

For local 0-10 V control from, for example room sensors, the FENIX 0-10 V module is used.





## Inputs and outputs continued.

Connection terminals	Function	Description
4+5, 11+12, 18+19, 25+26	Connection of smoke detector circuits	Each smoke detector circuit should have a 2.2 kOhm's resistance mounted at the end of the circuit, see the wiring diagram. The terminating resistance of 2.2 kOhm is connected to the last detector in each circuit. If a central fire alarm and/or no smoke detectors are used, a resistance of 2.2 kOhm should not be installed on these terminals. Max 24 V DC 90 mA.
6-10, 13-17, 20-24, 27-31	Connection of fire damper	For standard ON/OFF dampers, the input is not used for 10 V, this is done only for regulating dampers, see wiring diagrams. The damper output on G and G0 is 24 V DC, max 10 VA per output. <b>Note! Only 1 fire damper per output!</b>
Inputs	Function	Description
32+33	External function test/resetting External alarm	In the event of a short circuit, the controller performs a functional test and may reset the external incoming alarm, provided that terminals 34+35 do not have an open circuit. These terminals cannot be jumpered for automatic resetting. Instead, see options under settings.
34+35	External incoming alarm	In the event of an open circuit between terminals, External incoming alarm is activated, jumpered on delivery and if External incoming alarm is not used.
36+37	Night mode	In the event of short circuiting of the terminals, the panel enters Night mode whereby all dampers close without the controller generating alarms. Used, for example, during intermittent operation. Night mode can also be a good safety measure for preventing the spread of combustion gases when the ventilation is switched off, duct-mounted smoke detectors do not have the same opportunity to detect smoke when no air is transported in the system.
Outputs	Function	Description
38+39+40	A-alarm	Programmable potential-free changeover contacts: Triggered detector (not changeable), Damper error, Network error (loss of communication to FENIX+), Detector error, External alarm, Internal battery needs to be replaced, Service alarm detector. Will also change-over at power outage. In normal operation, terminals 38+40 have contact. Drawn in de-energised/alarm mode. Max 24 V AC/DC, 3 A.
41+42+43	B-alarm	Programmable potential-free changeover contacts: Triggered detector, Damper error, Network error (loss of communication to FENIX+), Detector error, External alarm, Internal battery needs to be replaced, Service alarm detector. Will also changeover at power outage. In normal operation, terminals 41+43 have contact. Drawn in de-energised/alarm mode. Max 24 V AC/DC, 3 A.
44+45	External stop of fan/unit	Programmable potential-free changeover contacts: Triggered detector, Damper error, Network error (loss of communication to FENIX+), Detector error, External alarm, Automatic functional testing of fire dampers. Will also changeover at power outage. In normal operation, terminals 44+45 have contact. Drawn in de-energised/alarm mode. Max 24 V AC/DC, 3 A.
46+47+48	Bus contact, communication between FENIX and FENIX+	Communication cable between FENIX and FENIX+ is connected here.
	Network connection	Cable connection RJ45, 10Base-T/100Base-TX auto-negotiation Cable length Max. 100 m Cabling Min. Cat 5
	Addressing slave units	Addressing knob for slave unit (FENIX+ only). Connected slave units shall be addressed in the order: 1, 2, 3. Turn the knob clockwise to change the address. Default address is 1.
	Indication of communication between master unit FENIX and slave unit FENIX+	Green LED on Voltage on, everything OK Red LED on Battery problems FENIX4 Orange flashing 1 time/sec No contact between FENIX+ and FENIX4

- Measure the voltage with a multimeter use a well-known brand.

- Check cables using an Ohmmeter with all devices disconnected.

- Never use a megohmmeter!

- The connection and disconnection of all cables are made with FENIX4 master and FENIX+ slave unit de-energized.