

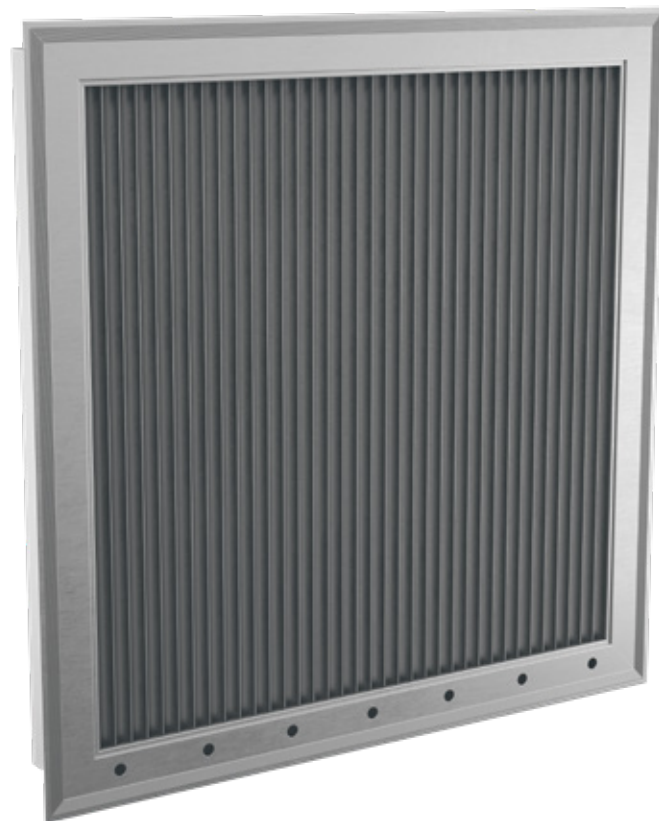

28/05/2024

# CALIGO

## Lifting and installation instructions



### GENERAL

- Lifting may be only performed by appropriately trained personnel.
- Lifting of products may only be carried out using lifting equipment approved for the intended purpose.
- Follow the instructions and guidelines that apply to the relevant lifting method and lifting accessories.
- Carefully read our instructions that apply to each product and size.
- Only the product may be lifted. Personnel lifting or lifting of any other kind may not take place in connection with lifting the louvre.
- Do not stand under suspended loads.
- Before lifting, check carefully that the specified lifting points are not damaged.
- Handle the louvre carefully before lifting so as not to damage the slats, as this may impair its performance.



### CALIGO weighing over 25 kg

When lifting Caligo, supplied eyebolts must be used in combination with chains, slings or straps. To compensate for angles or lengths, approved turnbuckles must be used.

1. Before lifting: Carefully read the general lifting instructions for Caligo (see page 1).
2. Caligo has 2 attachment points with associated eyebolts for lifting devices.  
The louvre is lifted from all lifting points.
3. Before lifting: Check that the lifting eye is tightened over its entire length so that it lies flat against the surface.
4. After lifting, remove the eyebolts and replace these with the screws provided.

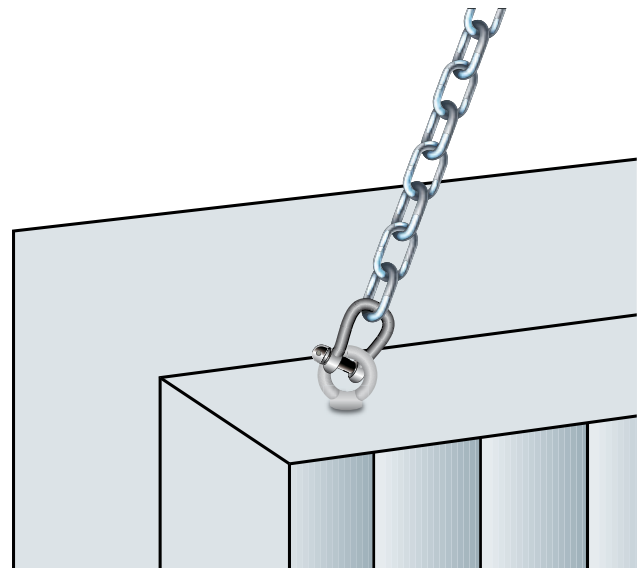
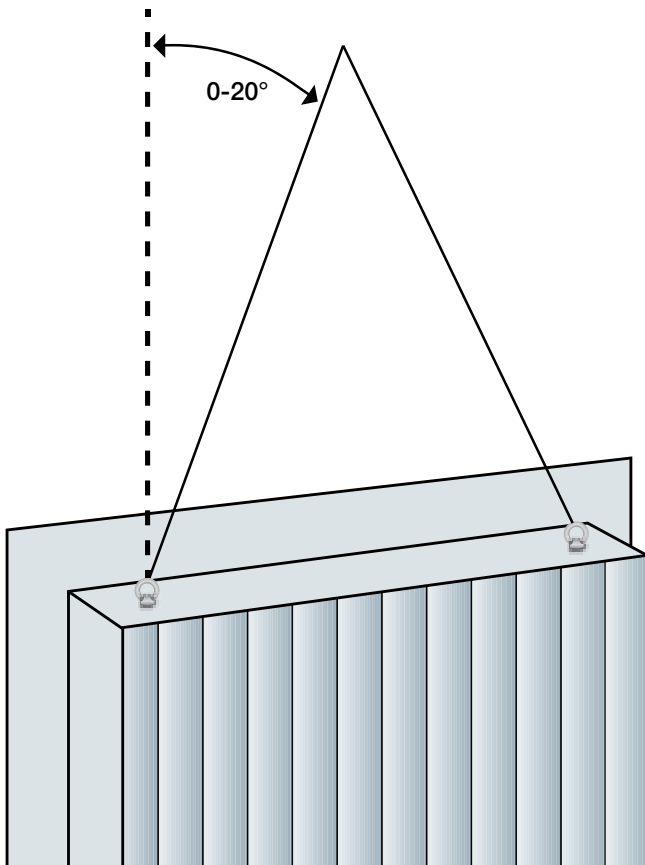

**Louvres weighing less than 25 kg are not expected to be lifted using a crane and therefore have no lifting points.**



## CALIGO can be installed in three different ways



Insert in the wall



Insert on the outside of the wall



Split version installed vertically, horizontally or both.

## GENERAL

- Always check that the hole dimensions match the louvre.
- Install the supplied gasket on the rear of the flange for sealing between louvre and wall.
- Always install the louvre with the drain holes facing down.
- Attachment to the wall is done using a suitable screw for the type of wall with a maximum of cc 300 mm between the attachment points.
- For adequate cathodic protection, a screw with rubber gasket is recommended for attachment.
- Use the blanking piece to prevent water from running down behind the louvre.



### CALIGO size up to 1,600x1,600, non-split version

The instructions show installation with the insert in the wall.

Installation with the insert on the outside of the wall is carried out in the same way.

1. Drill holes in the flange to then use for attachment to the wall. Max. cc 300 mm between holes.

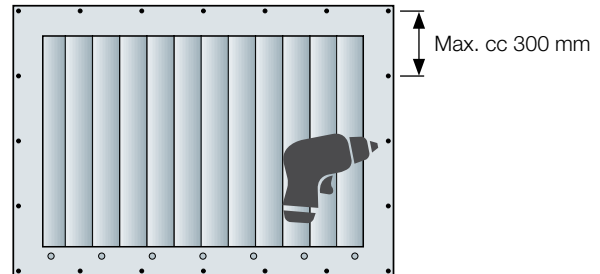

2. Attach the supplied gasket to the rear of the flange, i.e. the side that is against the wall.

It is important that there is a tight seal between the louvre and the wall to prevent water ingress.

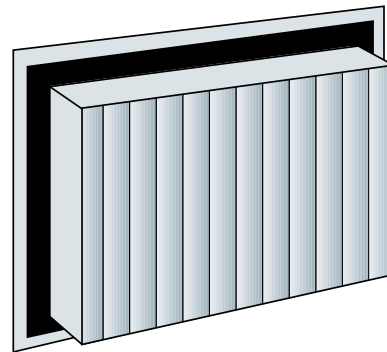

3. Install the louvre in the wall with the drain holes facing down and screw it into place through the holes drilled in step 1.

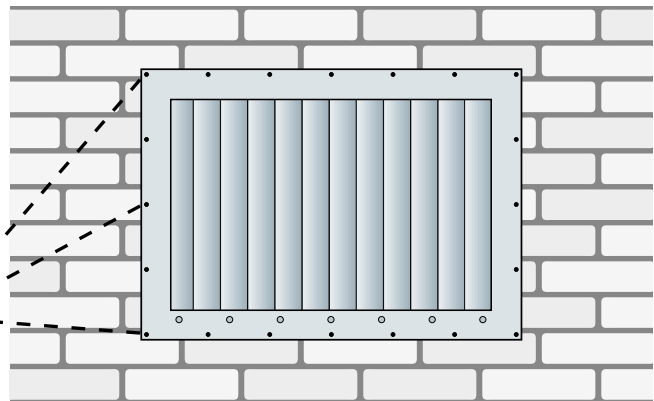
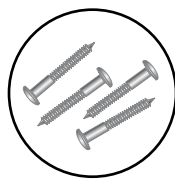

4. Seal the top edge of the louvre against the wall surface with putty.

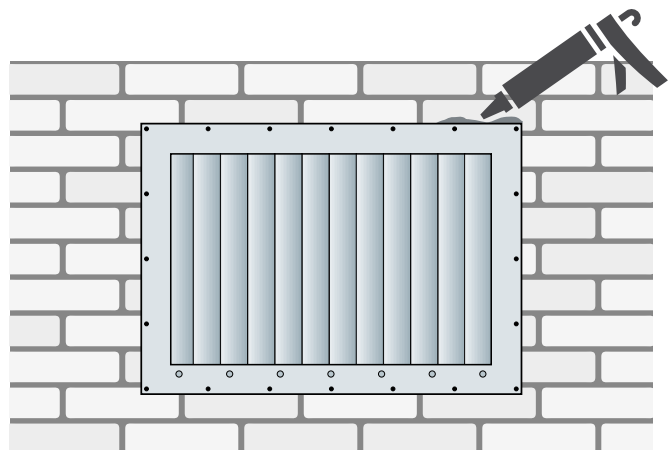



**CALIGO with height over 1,600 mm and width 1,600 mm or less**

1. Start by identifying which of the louvres should be installed on the top and the bottom.  
 The top louvre has no flange at the bottom edge, and the bottom louvre has no flange at the top edge.  
 The drain holes must face downwards.

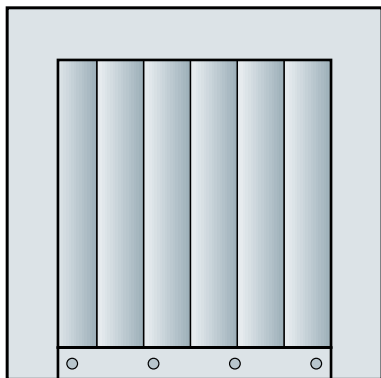

Top

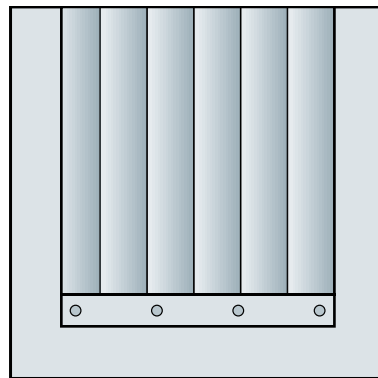

Bottom

2. Drill holes in the flange to then use for attachment to the wall. Max. cc 300 mm between holes.

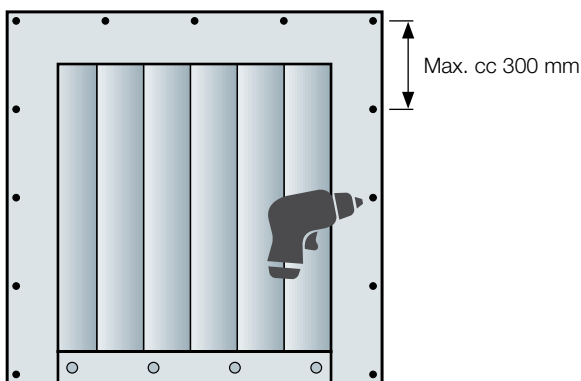

Top

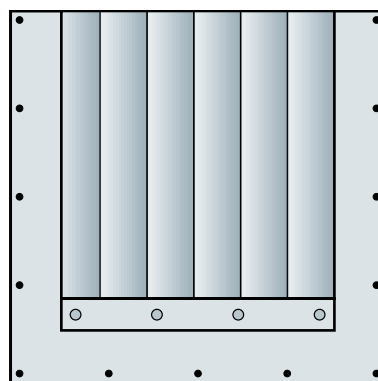

Bottom

3. Attach the supplied gasket to the rear of the flange, i.e. the side that is against the wall.

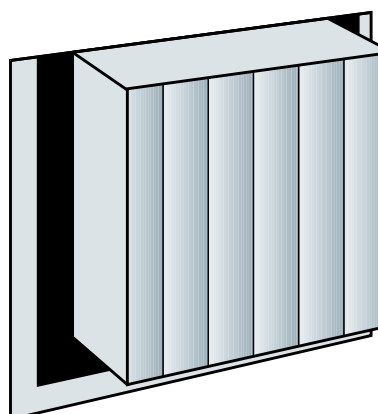
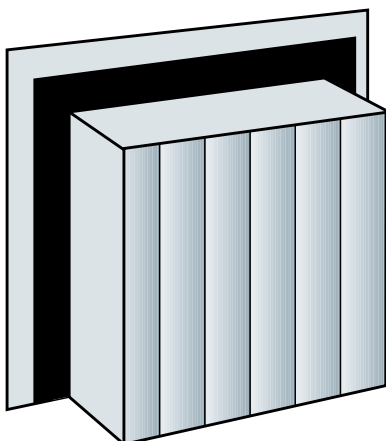



**CALIGO with height over 1,600 mm and width 1,600 mm or less, cont.**

- 4. First, install the bottom louvre in the wall and screw it to the wall through the holes drilled in step 1.

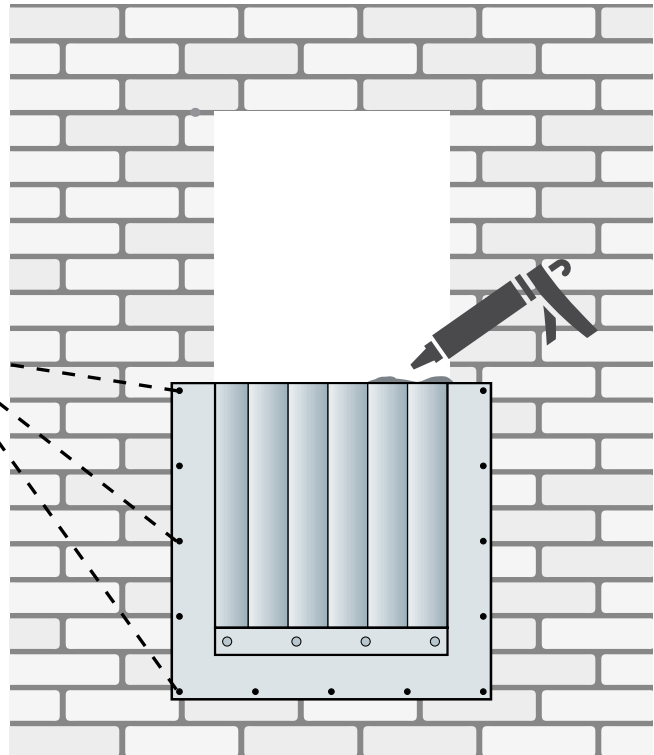
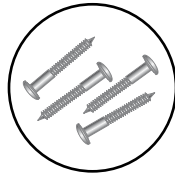

- 5. Apply putty to the louvre insert to seal between the top and bottom parts.

- 6. Install the top louvre to the bottom louvre and screw it to the wall through the holes drilled in step 1.

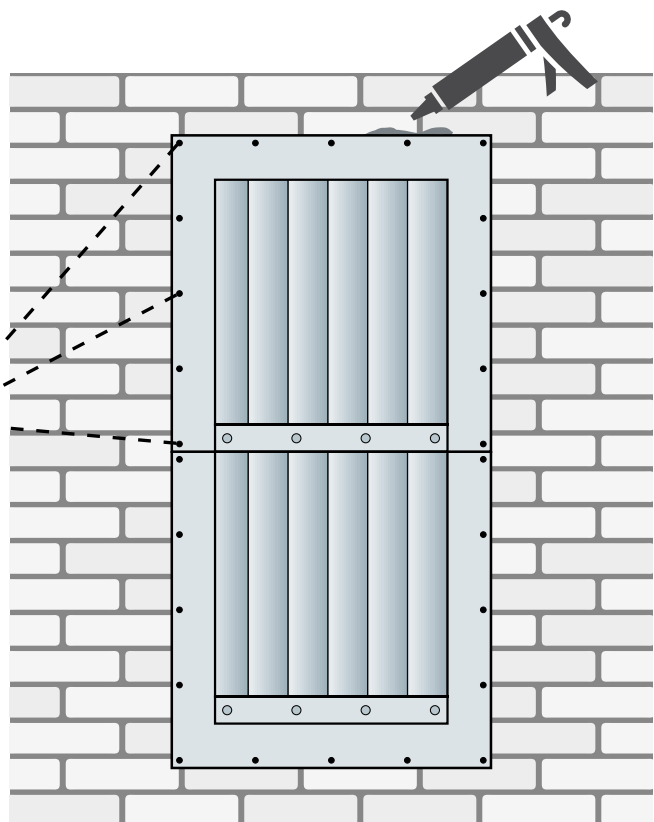
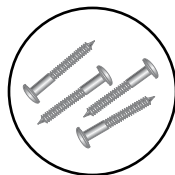

- 7. Seal the top edge of the louvre against the wall surface with putty.

Several louvres can be stacked on top of each other and then installed using the same method. The louvre(s) that are to sit between the top and bottom louvres then only have flange edges on the right and left-hand sides.



**CALIGO with width over 1,600 mm and height 1,600 mm or less**

1. Start by identifying which of the louvres should be installed on the left and the right.  
 The left louvre has no flange on the right-hand side and the right louvre has no flange on the left-hand side.  
 The drain holes must face downwards.

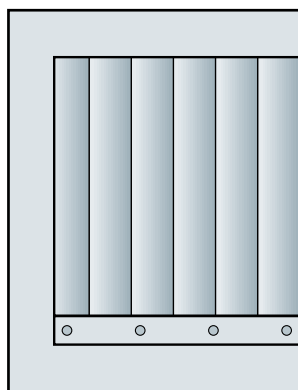

Left

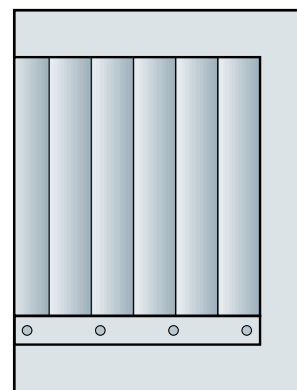

Right

2. Drill holes in the flange to then use for attachment to the wall. Max. cc 300 mm between holes.

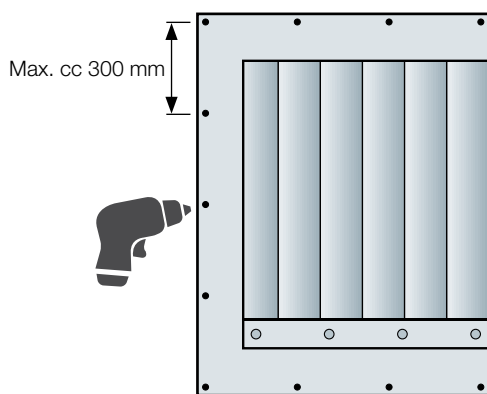

Left

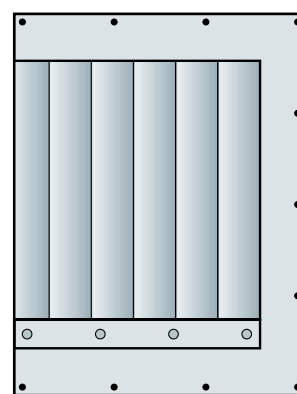

Right

3. Attach the supplied gasket to the rear of the flange, i.e. the side that is against the wall.

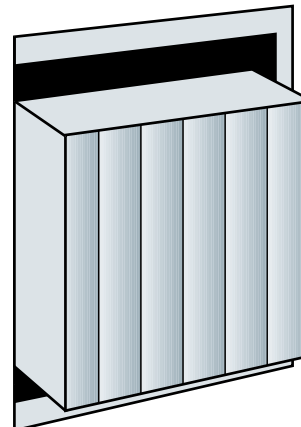
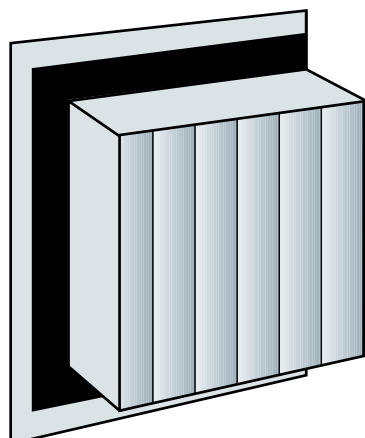

**CALIGO with width over 1,600 mm and height 1,600 mm or less, cont.**

4. Install the first louvre and screw it to the wall through the holes drilled in step 1.

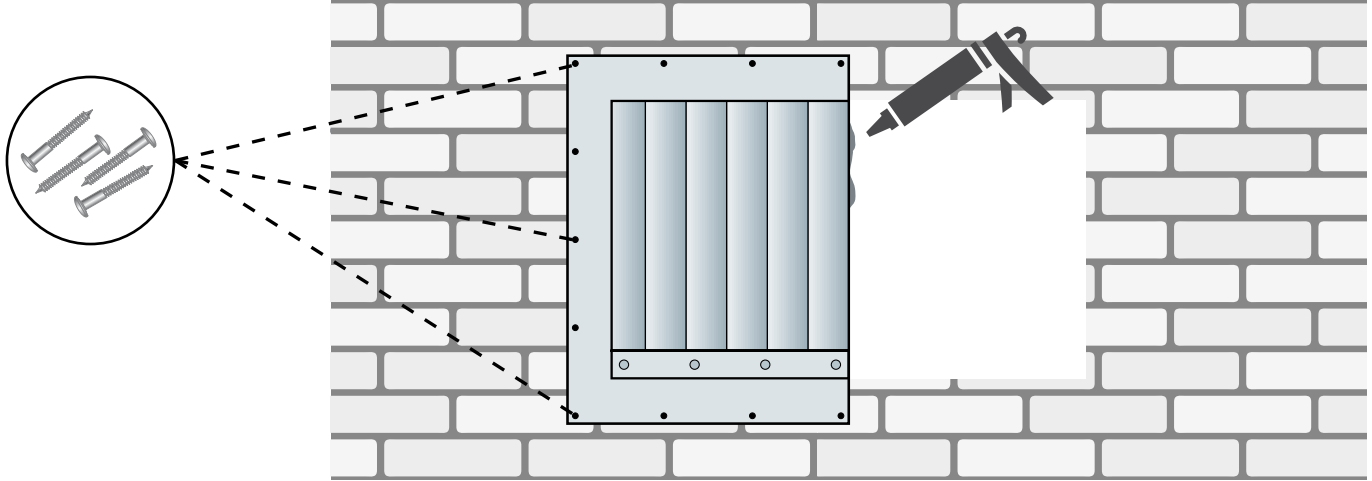

5. Apply putty to the louvre insert to seal between the left and right parts to prevent water ingress.

6. Install the second louvre against the first and screw it to the wall through the holes drilled in step 1.

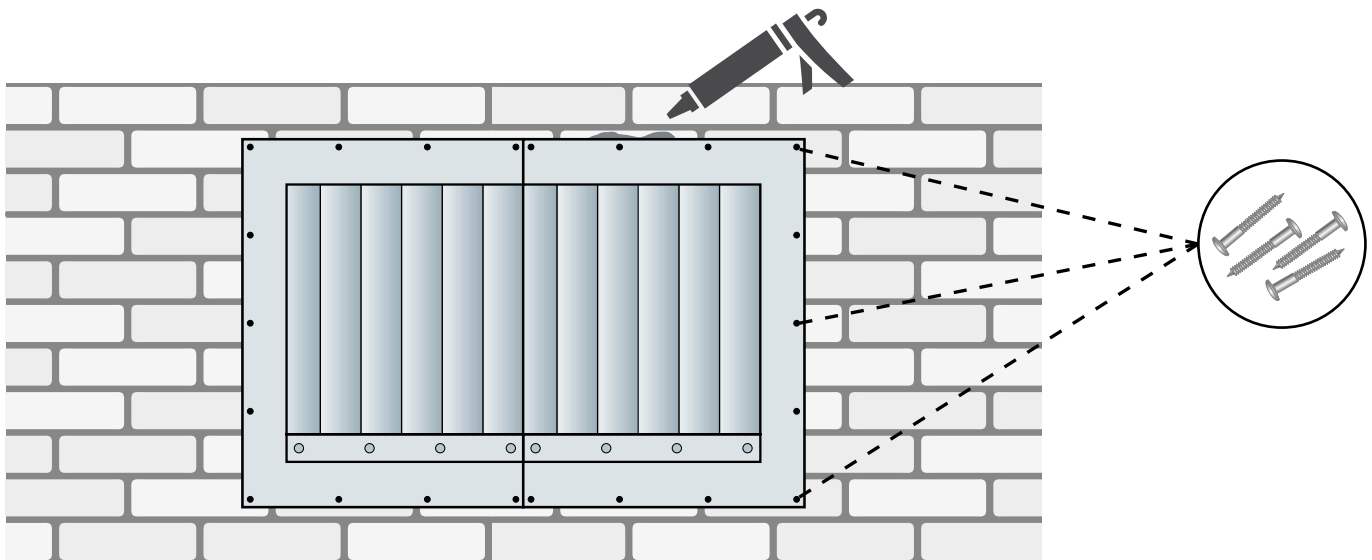

7. Seal the top edge of the louvre against the wall surface with putty.

Several louvres can be installed next to each other using the same method.

The louvre(s) that are to sit between those on the outside then only have flange edges on the top and bottom sides.





## CALIGO with width and height over 1,600 mm

1. Start by identifying which of the louvres should be mounted at the top and bottom.

A-B. The top louvres has no flange at the bottom edge.

C-D. The bottom louvres has no flange at the top edge.

The drain holes must face downwards.

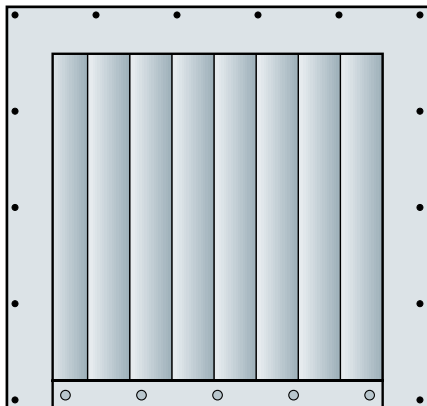

A.

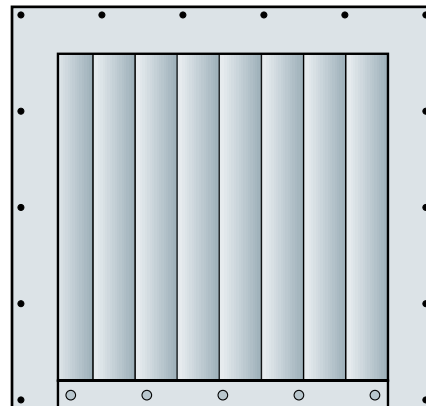

B.

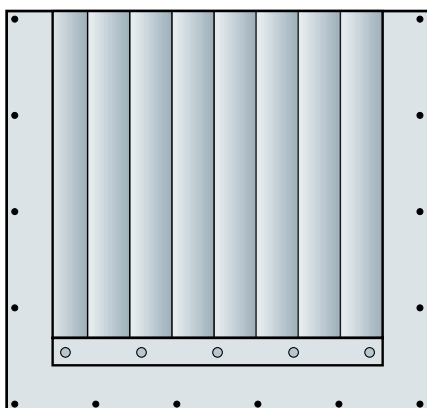

C.

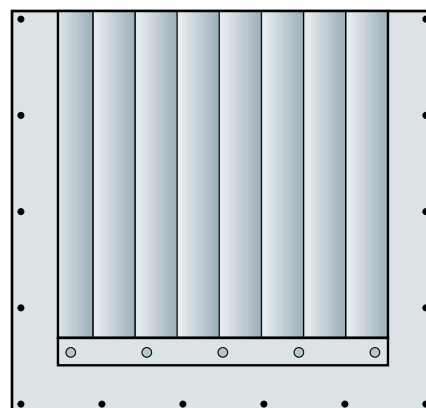

D.



**CALIGO with width and height over 1,600 mm, cont.**

2. Assemble the supplied U-beam by splicing the two profiles together.

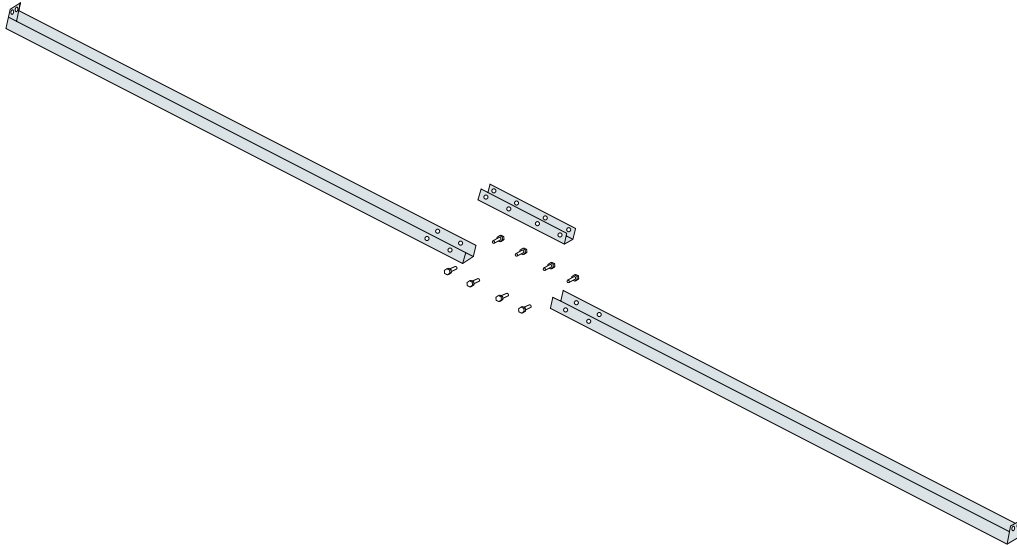

3. Install the U-beam. The beam is installed at the centre point of the top and bottom of the opening.  
The beam is mounted in line with the outer surface of the wall, with the short side facing the opening.  
Select fasteners according to the specific wall structure.

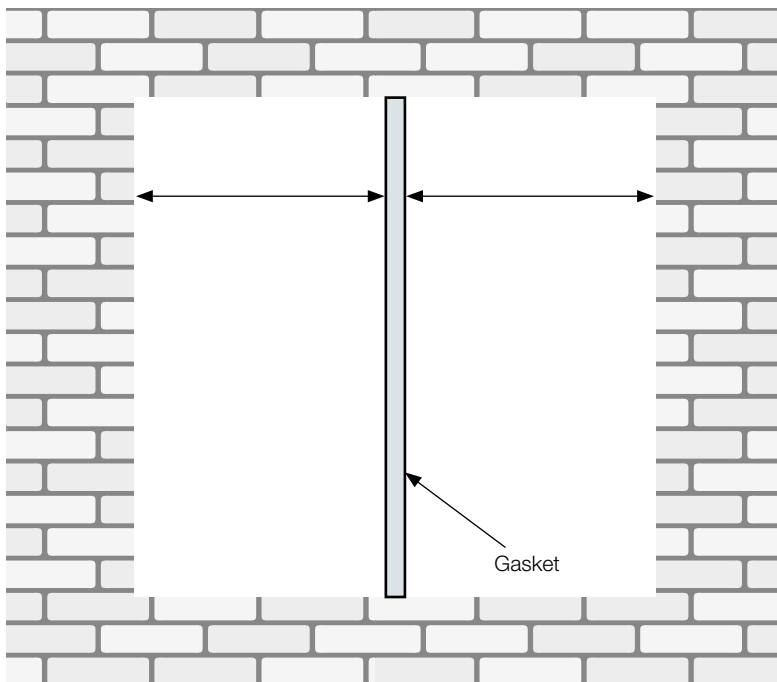

4. Attach the supplied gasket to the flat surface of the beam against the opening.



**CALIGO with width and height over 1,600 mm, cont.**

- 5. Follow the instructions for louvres installed vertically and install the top and bottom louvre on one side.

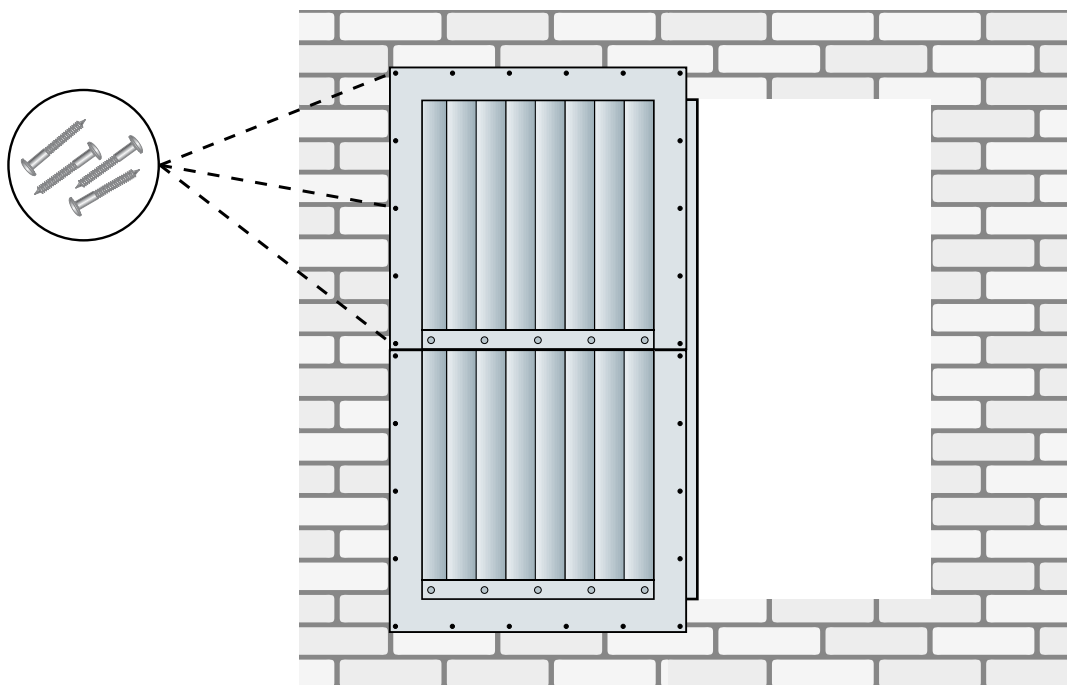

- 6. Then install the two remaining louvres like the previous ones.

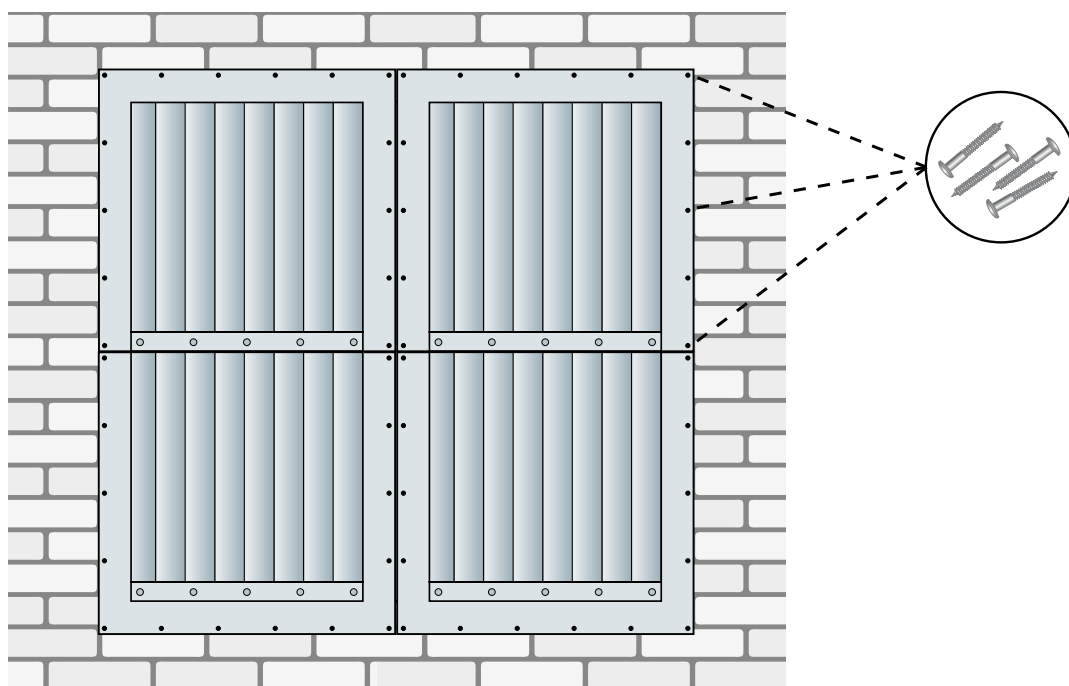



**CALIGO with width and height over 1,600 mm, cont.**

7. Seal the top edge of the louvre against the wall surface with putty to prevent water ingress.

